

Visualisation; Diagnostics

Easy to Configure

Programming IEC 61131-3

Rapid Installation

## PNOZ mm0.1p

- ▶ Configurable compact control systems PNOZmulti Mini

**PILZ**  
THE SPIRIT OF SAFETY

This document is a translation of the original document.

All rights to this documentation are reserved by Pilz GmbH & Co. KG. Copies may be made for internal purposes. Suggestions and comments for improving this documentation will be gratefully received.

Source code from third-party manufacturers or open source software has been used for some components. The relevant licence information is available on the Internet on the Pilz homepage.

Pilz®, PIT®, PMI®, PNOZ®, Primo®, PSEN®, PSS®, PVIS®, SafetyBUS p®, SafetyEYE®, SafetyNET p®, the spirit of safety® are registered and protected trademarks of Pilz GmbH & Co. KG in some countries.



SD means Secure Digital

<b>Section 1</b>	<b>Introduction</b>	<b>5</b>
	1.1 Validity of documentation	5
	1.2 Using the documentation	5
	1.3 Definition of symbols	5
<b>Section 2</b>	<b>Overview</b>	<b>7</b>
	2.1 Range	7
	2.2 Unit features	7
	2.3 Chip card	8
	2.4 Front view	9
<b>Section 3</b>	<b>Safety</b>	<b>10</b>
	3.1 Intended use	10
	3.2 System requirements	10
	3.3 Safety regulations	10
	3.3.1 Safety assessment	10
	3.3.2 Use of qualified personnel	11
	3.3.3 Warranty and liability	11
	3.3.4 Disposal	11
	3.3.5 For your safety	11
<b>Section 4</b>	<b>Function description</b>	<b>12</b>
	4.1 Integrated protection mechanisms	12
	4.2 Functions	12
	4.3 System reaction time	12
	4.4 Diagnostics	12
	4.5 Block diagram	13
<b>Section 5</b>	<b>Installation</b>	<b>14</b>
	5.1 Control cabinet installation	14
	5.1.1 Mounting distances	14
	5.2 Dimensions	15
	5.3 Install base unit without expansion module	16
	5.4 Connecting the base unit and expansion modules	16
<b>Section 6</b>	<b>Commissioning</b>	<b>18</b>
	6.1 General wiring guidelines	18
	6.2 Preparing for operation	18
	6.2.1 Function test during commissioning	18
	6.2.2 Using the chip card	19
	6.2.3 Commissioning the PNOZmulti safety system	19
	6.2.3.1 Load project from chip card	20
	6.2.3.2 Load project via USB port	20
	6.2.4 Connection	20
	6.3 Connection example	22

<b>Section 7</b>	<b>Operation</b>	<b>23</b>
	7.1 LED indicators	23
	7.2 Display indicators	24
	7.2.1 Rotary knob	26
	7.2.1.1 Function	26
	7.2.1.2 Pull out and retract the knob	26
	7.2.1.3 Rotate and press the knob	26
	7.2.2 Switch between menu levels	27
	7.2.3 Unit diagnostics on the LC display	27
	7.2.4 Error stack on the LC display	28
<b>Section 8</b>	<b>Technical details</b>	<b>30</b>
	8.1 Safety characteristic data	33
<b>Section 9</b>	<b>Supplementary data</b>	<b>35</b>
	9.1 Maximum capacitive load C ( $\mu\text{F}$ ) with load current I (A) at the semiconductor outputs	35
	9.2 Maximum permitted total current of the semiconductor outputs	35
<b>Section 10</b>	<b>Order reference</b>	<b>36</b>
	10.1 Product	36
	10.2 Accessories	36

# 1 Introduction

## 1.1 Validity of documentation

This documentation is valid for the product PNOZ mm0.1p. It is valid until new documentation is published.

This operating manual explains the function and operation, describes the installation and provides guidelines on how to connect the product.

## 1.2 Using the documentation

This document is intended for instruction. Only install and commission the product if you have read and understood this document. The document should be retained for future reference.

## 1.3 Definition of symbols

Information that is particularly important is identified as follows:



### **DANGER!**

This warning must be heeded! It warns of a hazardous situation that poses an immediate threat of serious injury and death and indicates preventive measures that can be taken.



### **WARNING!**

This warning must be heeded! It warns of a hazardous situation that could lead to serious injury and death and indicates preventive measures that can be taken.



### **CAUTION!**

This refers to a hazard that can lead to a less serious or minor injury plus material damage, and also provides information on preventive measures that can be taken.



### **NOTICE**

This describes a situation in which the product or devices could be damaged and also provides information on preventive measures that can be taken. It also highlights areas within the text that are of particular importance.



**INFORMATION**

This gives advice on applications and provides information on special features.

## 2 Overview

### 2.1 Range

- ▶ Base unit PNOZ mm0.1p
- ▶ Right-hand terminator: (yellow)
- ▶ Left-hand terminator: (yellow/black)

### 2.2 Unit features

Using the product PNOZ mm0.1p:

PNOZmulti Mini base unit

The product has the following features:

- ▶ Can be configured in the PNOZmulti Configurator
- ▶ Semiconductor outputs:
  - 4 safety outputs
  - Depending on the application, up to PL e of EN ISO 13849-1 and up to SIL CL 3 of EN IEC 62061
- ▶ 12 inputs for connecting, for example:
  - E-STOP pushbuttons
  - Two-hand button
  - Safety gate limit switches
  - Start buttons
  - Light beam devices
  - Scanners
  - Enabling switches
  - PSEN
  - Operating mode selector switches
  - Safety mats
- ▶ 8 configurable inputs/outputs
  - Can be configured as:
    - Inputs (see above for connection options)
  - or
    - Outputs for standard applications
- ▶ 4 configurable outputs
  - Can be configured as:
    - Outputs for standard applications
  - or
    - Test pulse outputs

- ▶ LED indicator for:
  - Error messages
  - Diagnostics
  - Supply voltage
  - Output circuits
  - Input circuits
- ▶ Display for:
  - Error messages
  - State of supply voltage
  - State of the inputs and outputs
  - Status information
  - Unit information
- ▶ Test pulse outputs used to monitor shorts across the inputs
- ▶ Monitoring of shorts between the safety outputs
- ▶ Plug-in connection terminals:  
Either spring-loaded terminal or screw terminal available as an accessory (see order reference)
- ▶ Rotary knob for menu control
- ▶ Expansion modules can be connected  
(please refer to the document "PNOZmulti System Expansion" for details of the type and number that can be connected)

## 2.3 Chip card

To be able to use the product you will need a chip card.

Chip cards are available with memories of 8 kByte and 32 kByte. For large-scale projects we recommend the 32 kByte chip card (see Technical Catalogue: Accessories chapter).



## 2.4 Front view

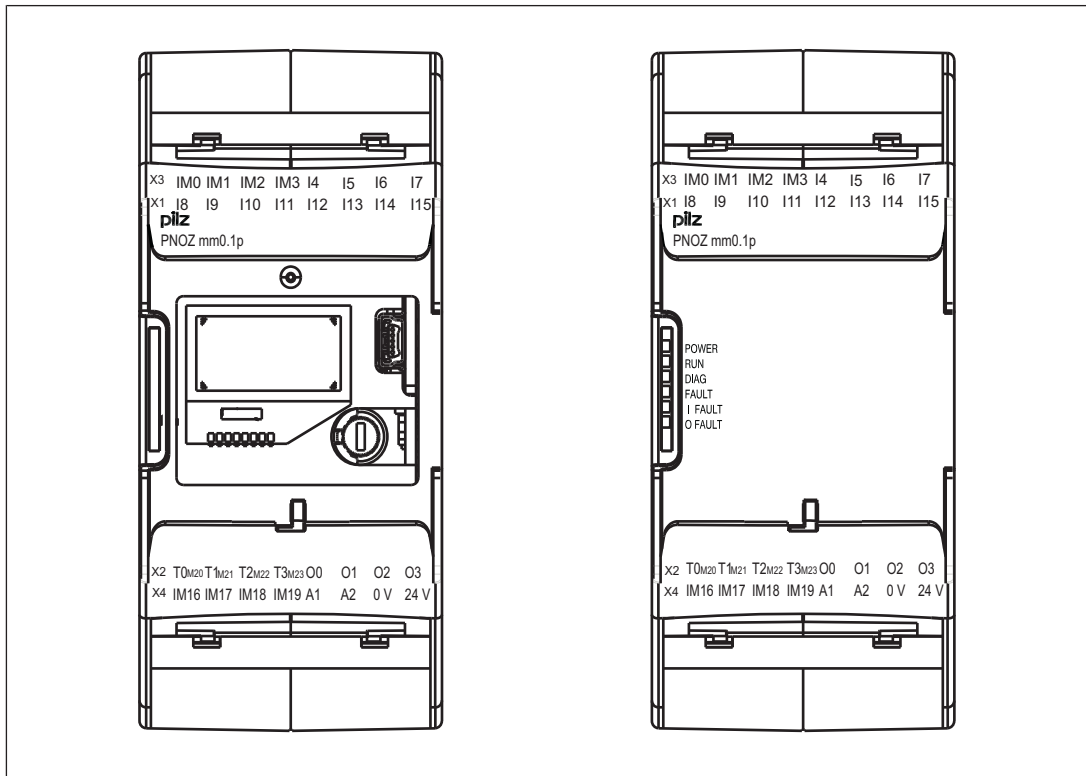

Front view with and without cover

### Legend

- X1: Inputs I8 ... I15
- X1: Configurable test pulse/auxiliary outputs T0M20 ... T3M23
- Semiconductor outputs O0 ... O3
- X3: Configurable inputs/outputs IM0 – IM3
- Inputs I4 ... I7
- X4: Configurable inputs/outputs IM16 – IM19
- Supply connections
- LEDs: PWR
- RUN
- DIAG
- FAULT
- I FAULT
- O FAULT

## 3 Safety

### 3.1 Intended use

The configurable system is used for the safety-related interruption of safety circuits and is designed for use in:

- ▶ Emergency stop equipment
- ▶ Safety circuits in accordance with VDE 0113 Part 1 and EN 60204-1



#### CAUTION!

Inputs and outputs for standard functions must not be used for safety-related applications.

The following is deemed improper use in particular:

- ▶ Any component, technical or electrical modification to the product
- ▶ Use of the product outside the areas described in this manual
- ▶ Use of the product outside the technical details (see [Technical details](#) [ 30]).



#### NOTICE

EMC-compliant electrical installation

The product is designed for use in an industrial environment. The product may cause interference if installed in other environments. If installed in other environments, measures should be taken to comply with the applicable standards and directives for the respective installation site with regard to interference.

### 3.2 System requirements

Please refer to the "Product Modifications" document in the "Version overview" section for details of which versions of the PNOZmulti Configurator can be used for this product.

### 3.3 Safety regulations

#### 3.3.1 Safety assessment

Before using a unit it is necessary to perform a safety assessment in accordance with the Machinery Directive.

Functional safety is guaranteed for the product as a single component. However, this does not guarantee the functional safety of the overall plant/machine. In order to achieve the required safety level for the overall plant/machine, define the safety requirements for the plant/machine and then define how these must be implemented from a technical and organisational standpoint.

### 3.3.2 Use of qualified personnel

The products may only be assembled, installed, programmed, commissioned, operated, maintained and decommissioned by competent persons.

A competent person is someone who, because of their training, experience and current professional activity, has the specialist knowledge required to test, assess and operate the work equipment, devices, systems, plant and machinery in accordance with the general standards and guidelines for safety technology.

It is the company's responsibility only to employ personnel who:

- ▶ Are familiar with the basic regulations concerning health and safety / accident prevention
- ▶ Have read and understood the information provided in this description under "Safety"
- ▶ And have a good knowledge of the generic and specialist standards applicable to the specific application.

### 3.3.3 Warranty and liability

All claims to warranty and liability will be rendered invalid if

- ▶ The product was used contrary to the purpose for which it is intended
- ▶ Damage can be attributed to not having followed the guidelines in the manual
- ▶ Operating personnel are not suitably qualified
- ▶ Any type of modification has been made (e.g. exchanging components on the PCB boards, soldering work etc.).

### 3.3.4 Disposal

- ▶ In safety-related applications, please comply with the mission time  $T_M$  in the safety-related characteristic data.
- ▶ When decommissioning, please comply with local regulations regarding the disposal of electronic devices (e.g. Electrical and Electronic Equipment Act).

### 3.3.5 For your safety

The device meets all the necessary conditions for safe operation. However, you should always ensure that the following safety requirements are met:

- ▶ This operating manual only describes the basic functions of the device. Advanced functions are described in the online help for the PNOZmulti Configurator, in the "PNOZmulti Communication Interfaces" document and in "PNOZmulti Special Applications". Only use these functions once you have read and understood the documentation.
- ▶ You must note the information stated in the PNOZmulti Safety Manual.
- ▶ Adequate protection must be provided for all inductive consumers.
- ▶ Do not open the housing or make any unauthorised modifications.
- ▶ Please make sure you shut down the supply voltage when performing maintenance work (e.g. exchanging contactors).

## 4 Function description

### 4.1 Integrated protection mechanisms

The relay conforms to the following safety criteria:

- ▶ The circuit is redundant with built-in self-monitoring.
- ▶ The safety function remains effective in the case of a component failure.
- ▶ The safety outputs are tested periodically using a disconnection test.

### 4.2 Functions

The function of the inputs and outputs on the control system depends on the safety circuit created using the PNOZmulti Configurator. A chip card is used to download the safety circuit to the base unit. The base unit has 2 microcontrollers that monitor each other. They evaluate the input circuits on the base unit and expansion modules and switch the outputs on the base unit and expansion modules accordingly.

The LEDs on the base unit and expansion modules indicate the status of the configurable control system PNOZmulti.

The online help on the PNOZmulti Configurator contains descriptions of the operating modes and all the functions of the control system, plus connection examples.

### 4.3 System reaction time

Calculation of the maximum reaction time between an input switching off and a linked output in the system switching off is described in the document "PNOZmulti System Expansion".

### 4.4 Diagnostics

The status and error messages displayed by the LEDs are saved in an error stack. This error stack can be shown on the display or can be read from the PNOZmulti Configurator via the USB port.

### 4.5 Block diagram

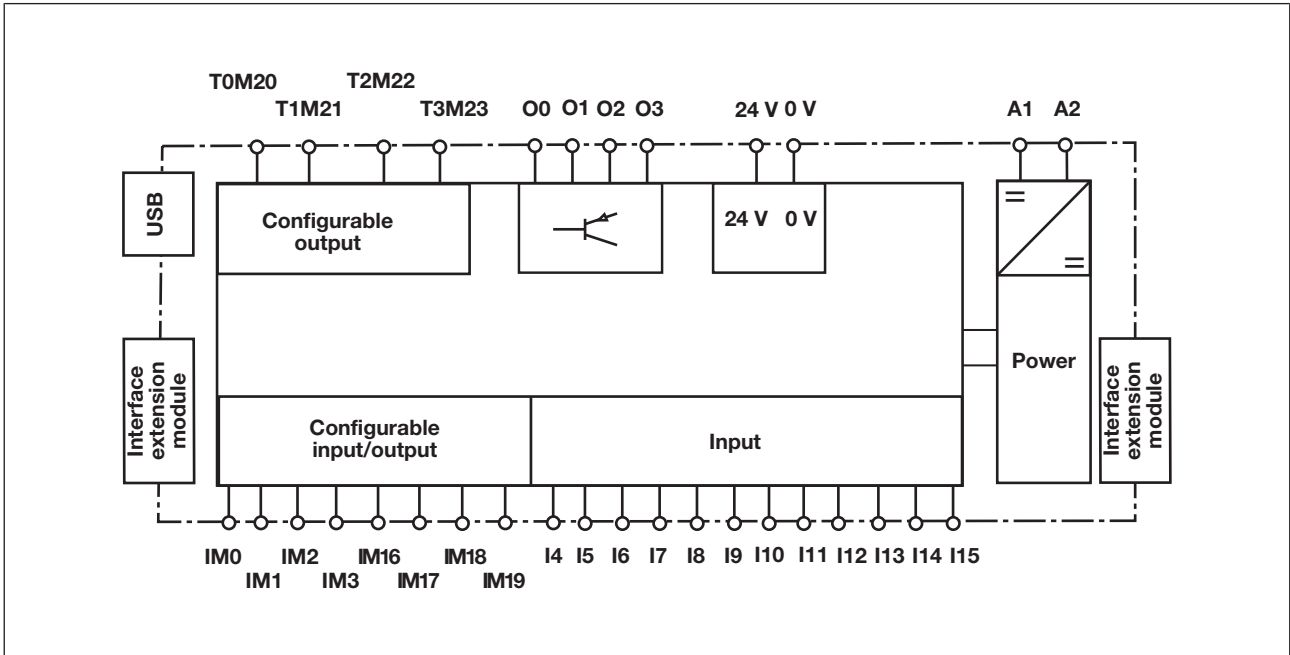

## 5 Installation

### 5.1 Control cabinet installation

- ▶ The unit should be installed in a control cabinet with a protection type of at least IP54.
- ▶ Fit the safety system to a horizontal mounting rail. The venting slots must face upwards and downwards. Other mounting positions could destroy the safety system.
- ▶ Use the notch on the rear of the unit to attach it to a mounting rail.
- ▶ In environments exposed to heavy vibration, the unit should be secured using a fixing element (e.g. retaining bracket or end angle).
- ▶ Push the unit upwards or downwards before lifting it from the mounting rail.
- ▶ To comply with EMC requirements, the mounting rail must have a low impedance connection to the control cabinet housing.



#### **NOTICE**

Damage due to electrostatic discharge!

Electrostatic discharge can damage components. Ensure against discharge before touching the product, e.g. by touching an earthed, conductive surface or by wearing an earthed armband.

#### 5.1.1 Mounting distances

With control cabinet installation it is essential to maintain a certain distance from the top and bottom, as well as to other heat-producing devices (see diagram). The values stated for the mounting distances are minimum specifications.

The ambient temperature in the control cabinet must not exceed the figure stated in the technical details. Air conditioning may otherwise be required.

Mounting distances:

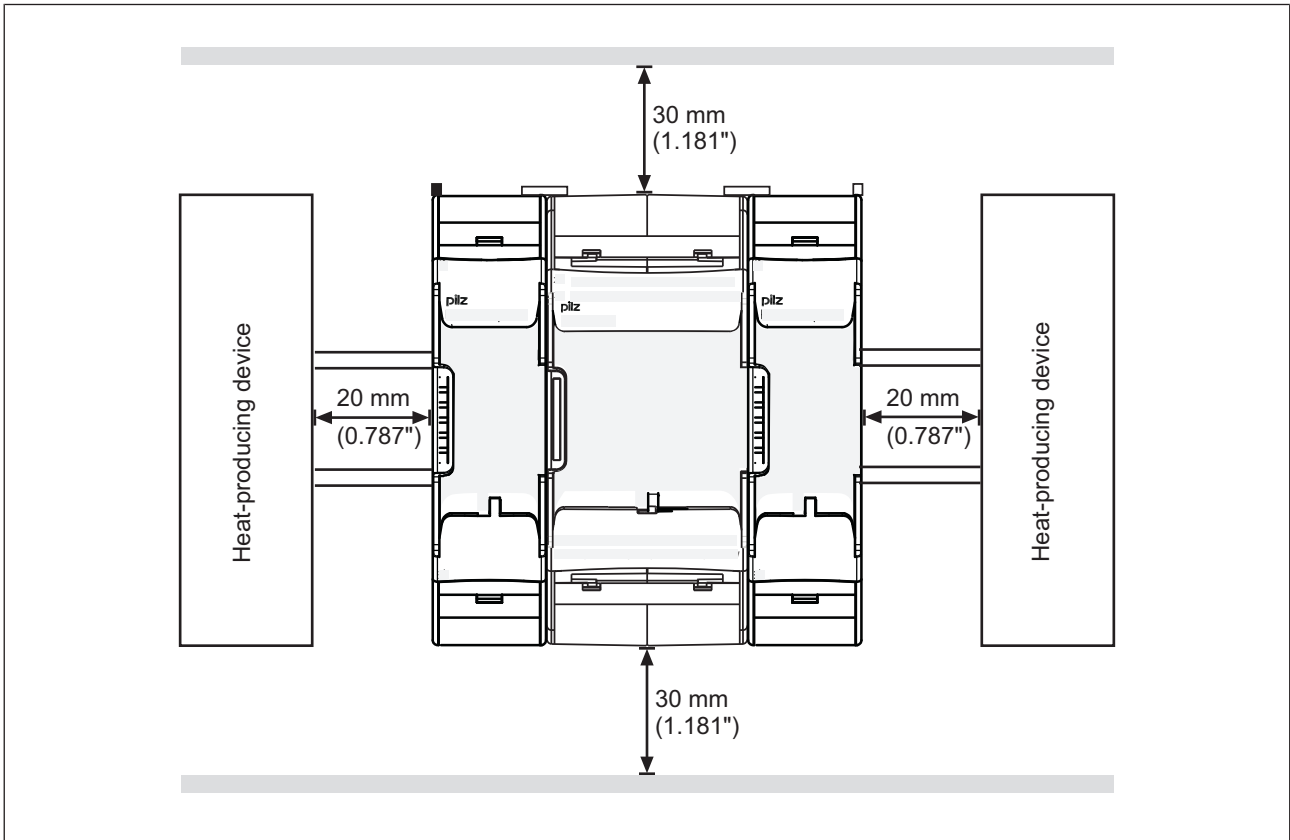

## 5.2 Dimensions

\*with spring-loaded terminals

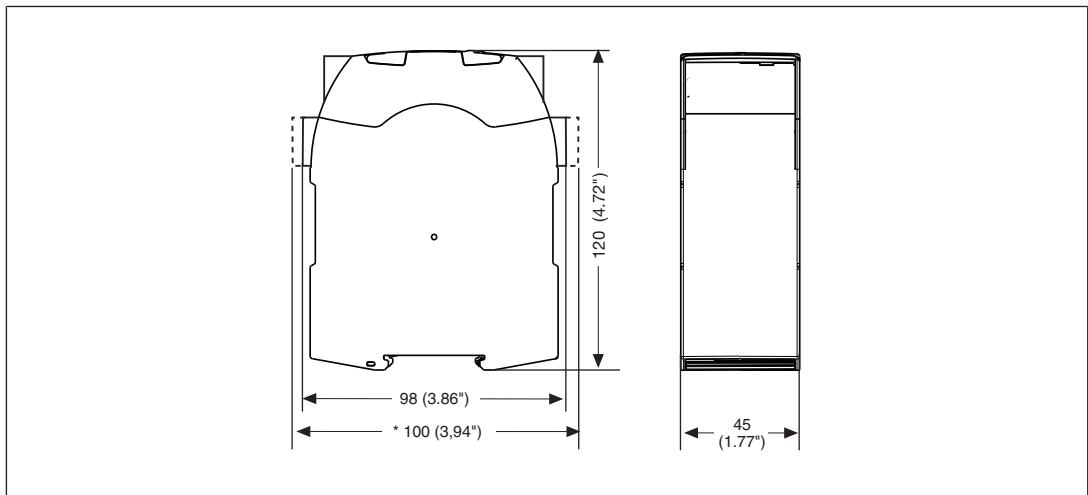

### 5.3 Install base unit without expansion module

Make sure that the terminators are inserted on the top left and right of the unit :

- ▶ Left: Black/yellow terminator
- ▶ Right: Yellow terminator

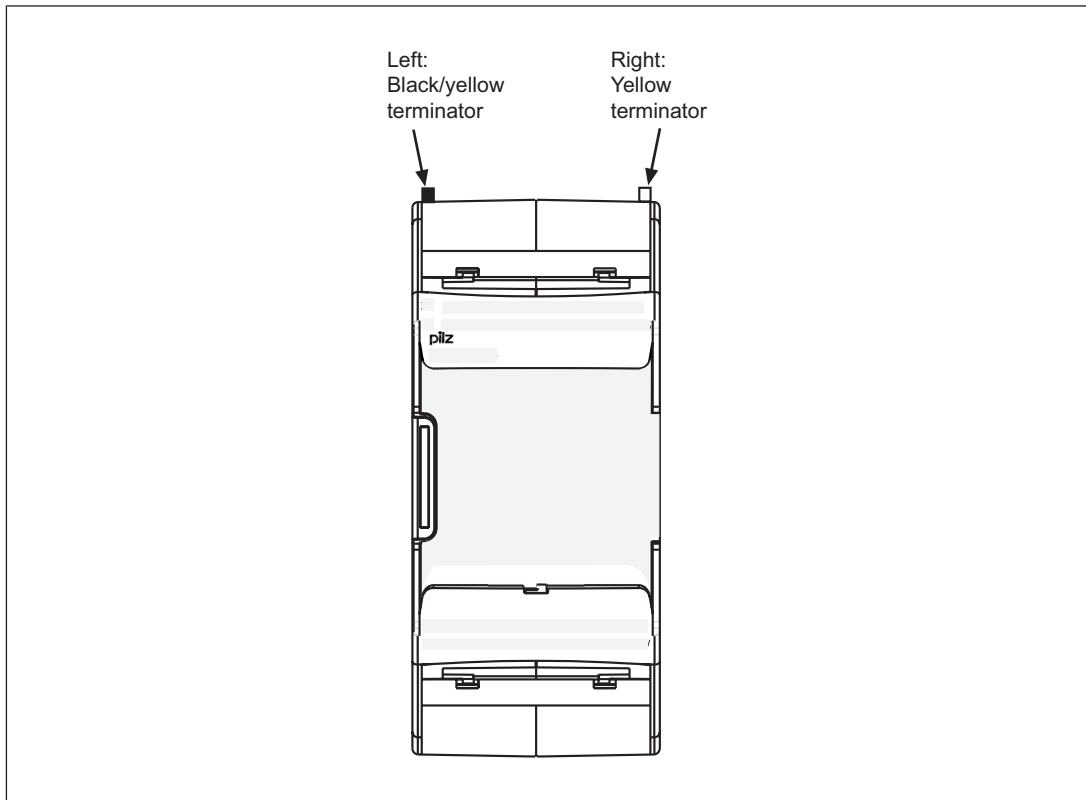

### 5.4 Connecting the base unit and expansion modules

The position of the expansion modules is defined in the PNOZmulti Configurator. The expansion modules are connected to the left or right of the base unit, depending on the type. Please refer to the document "PNOZmulti System Expansion" for details of the number of modules that can be connected to the base unit and the module types.

The modules are linked via jumpers.

- ▶ Remove the terminator on the side of the base unit and on the expansion module.
- ▶ Before installing the units on the mounting rail, connect the base unit to the expansion module using the jumper supplied .

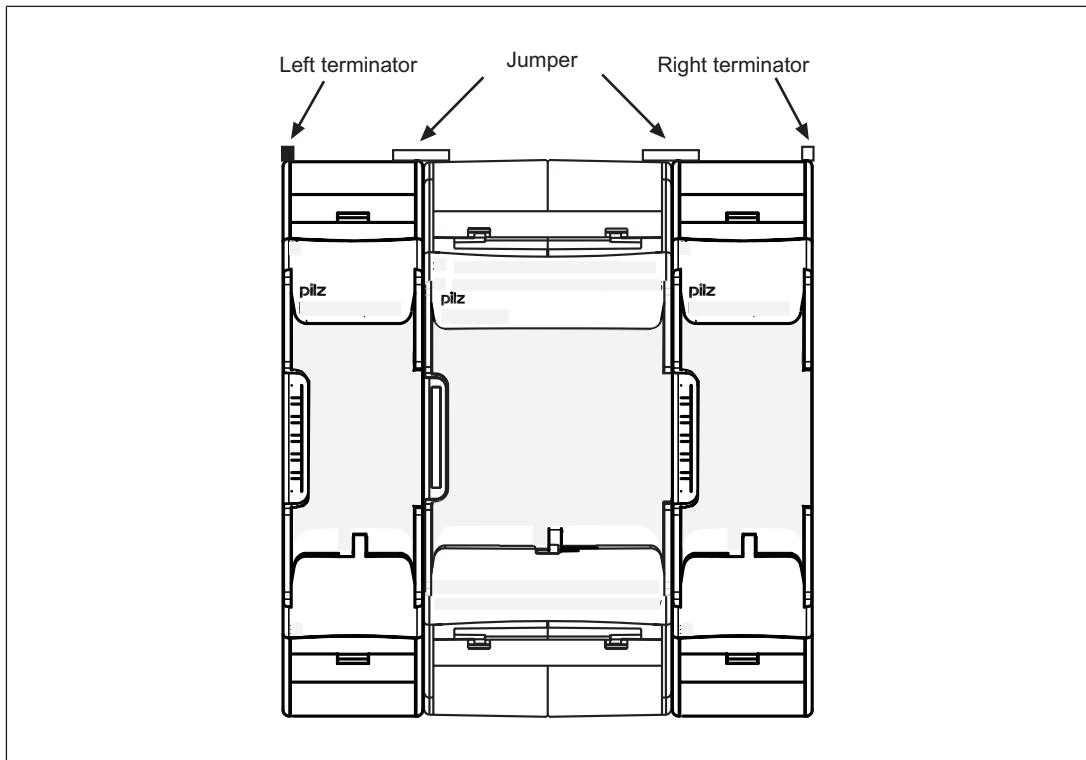

- ▶ Fit the appropriate terminator to the unconnected interfaces on the base unit and expansion module.
  - Left-hand side on the base unit and expansion modules to the left of the base unit: Black/yellow terminator
  - Right-hand side on the base unit and expansion modules to the right of the base unit: Yellow terminator

**CAUTION!**

Only connect the base unit and expansion modules when the supply voltage is switched off.

## 6 Commissioning

### 6.1 General wiring guidelines

The wiring is defined in the circuit diagram in the Configurator. There you can select the inputs that are to perform a safety function and the outputs that are to switch this safety function.

Please note:

- ▶ Information given in the [Technical details](#) [ 30] must be followed.
- ▶ Outputs O0 to O3 are semiconductor outputs
- ▶ Use copper wiring with a temperature stability of 75 °C.
- ▶ Sufficient fuse protection must be provided on all output contacts with inductive loads.
- ▶ The safety system and input circuits must always be supplied by a single power supply. The power supply must meet the regulations for extra low voltages with protective separation.
- ▶ Test pulse outputs must exclusively be used to test the inputs. They must not be used to drive loads.  
Do not route the test pulse lines together with actuator cables within an unprotected multicore cable.
- ▶ Test pulse outputs are also used to supply safety mats that trigger a short circuit.  
Test pulses that are used for the safety mat may not be reused for other purposes.

### 6.2 Preparing for operation

#### 6.2.1 Function test during commissioning



#### CAUTION!

It is essential to check that the safety devices operate correctly

- after the chip card has been exchanged
- after a project has been downloaded
- when the project has been deleted from the base unit's memory ("Reset Project" menu)

## 6.2.2 Using the chip card



### NOTICE

The chip card contact is only guaranteed if the contact surface is clean and undamaged. For this reason please protect the chip card's contact surface from

- Contamination
- Contact
- Mechanical impact, such as scratches.



### NOTICE

Switch off the product before inserting or exchanging the chip card.

Make sure that you do not bend the chip card as you insert it into the chip card slot.

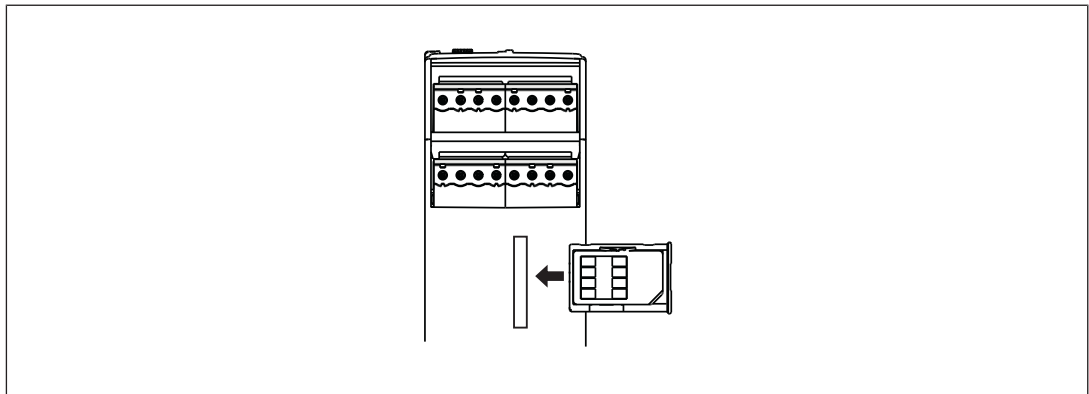

## 6.2.3 Commissioning the PNOZmulti safety system

Procedure:

- ▶ Wire the inputs and outputs on the base unit in accordance with the circuit diagram.
- ▶ Connect the supply voltage:
  - Supply voltage for the control system:
  - Terminal A1: + 24 VDC
  - Terminal A2: 0 V
  - Supply voltage for the semiconductor outputs:
  - 24 V terminal: + 24 VDC
  - 0V terminal: 0 V

Please note: The supply voltage for the semiconductor outputs must always be present, even if you are not using the semiconductor outputs.



**CAUTION!**  
Do not connect or disconnect expansion modules and terminators during operation.

**6.2.3.1 Load project from chip card**

Procedure:

- ▶ Insert the chip card containing the current project into the card slot on the base unit.
- ▶ Switch on the supply voltage. The LC display shows the project name, CRC sum and the date the project was created. Please check this information.
- ▶ Load the project by pressing the rotary knob. For the project to be downloaded, the rotary knob must be held down for between 3 and 8 seconds. Once the project has been successfully downloaded, the status of the inputs and outputs will be shown on the display.

**6.2.3.2 Load project via USB port**

Procedure:

- ▶ Insert a chip card into the card slot on the base unit.
- ▶ Connect the computer containing the PNOZmulti Configurator to the base unit via the USB port.
- ▶ Switch on the supply voltage.
- ▶ Download the project (see PNOZmulti Configurator's online help).
- ▶ Once the project has been successfully downloaded, the status of the inputs and outputs and the supply voltage will be shown on the display. The "RUN" LED will be lit.

**6.2.4 Connection**

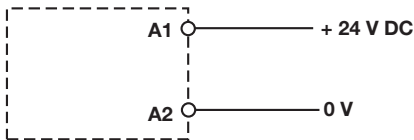
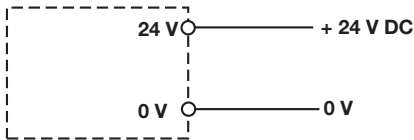
Supply voltage	AC	DC
For the safety system	/	
For the semiconductor outputs Must always be present, even if the semiconductor outputs are not used	/	

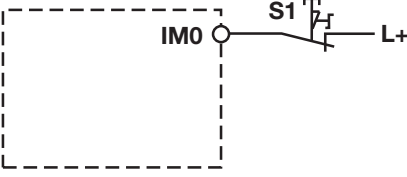
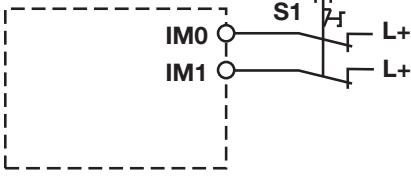
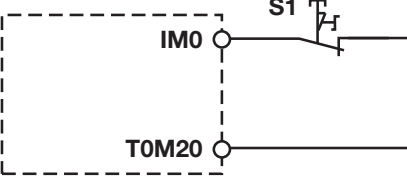
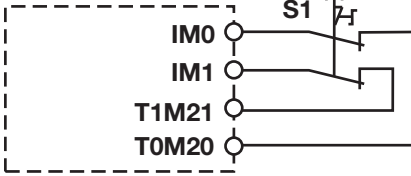
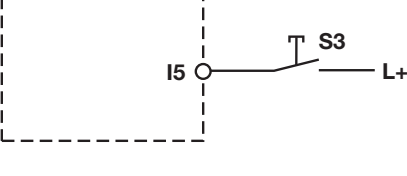
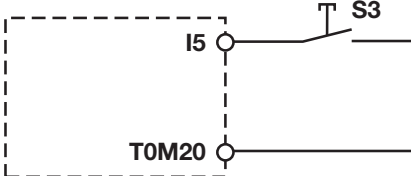
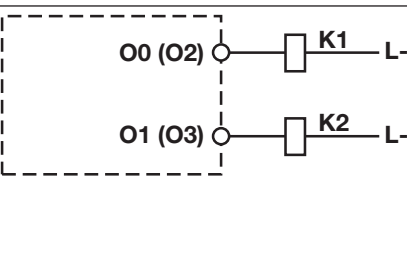
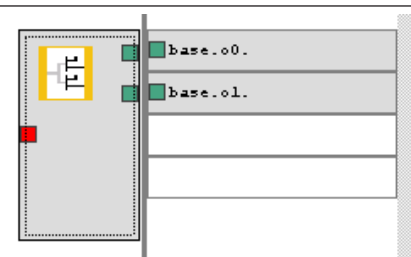
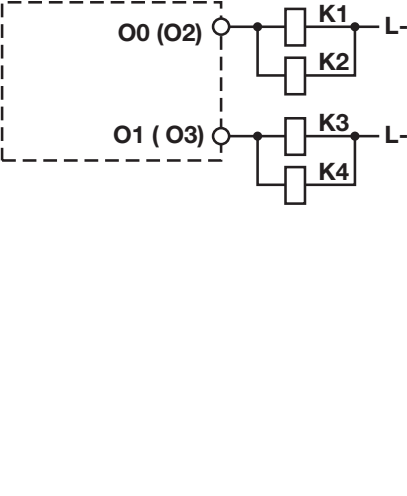
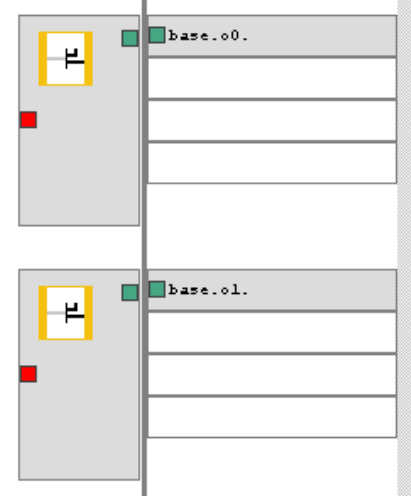
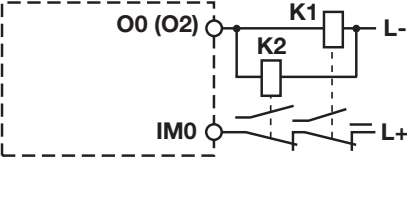
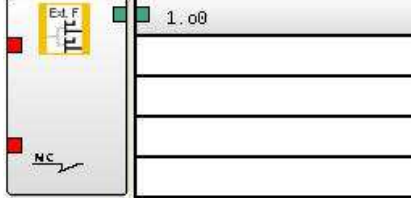
Input circuit	Single-channel	Dual-channel
E-STOP <b>without</b> detection of shorts across contacts		
E-STOP <b>with</b> detection of shorts across contacts		
Start circuit	Input circuit without detection of shorts across contacts	Input circuit with detection of shorts across contacts
		
Redundant output		
Single output		
Single output with advanced fault detection*		

\*Two loads may be connected to each safety output with advanced fault detection, even on applications in accordance with EN IEC 62061, SIL CL 3. Prerequisite: Feedback loop is connected, shorts across contacts and external power sources are excluded (e.g. through separate multicore cables). Please note that, in the event of an error in the feedback loop, the safety system switches to a safe condition and shuts down **all** the outputs.

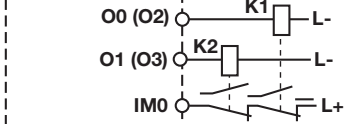
Feedback loop	Redundant output
Contacts from external contactors	

### 6.3 Connection example

Dual-channel E-STOP and safety gate wiring, monitored start (IM18), feedback loop (IM16)

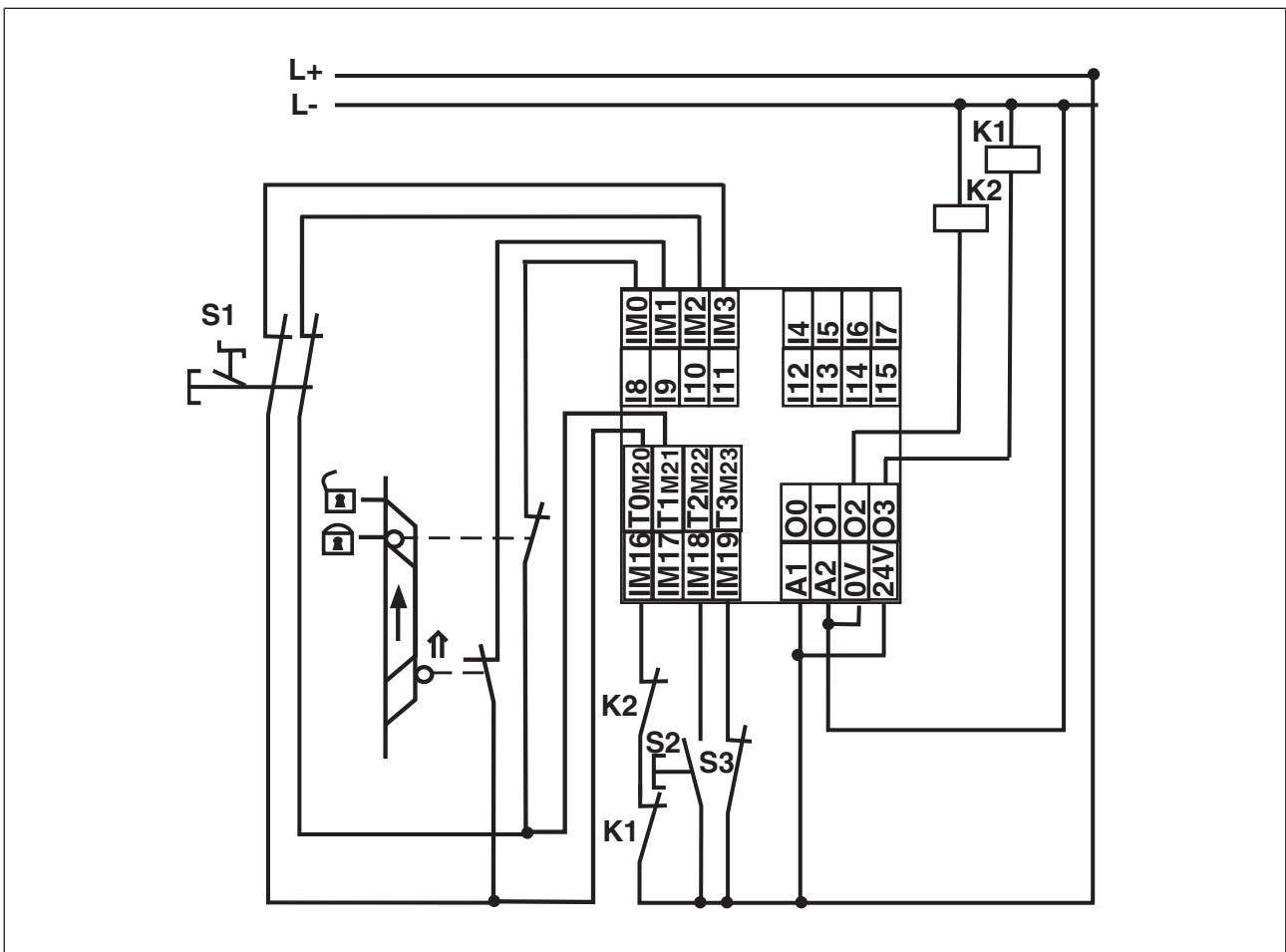



















# 7 Operation

## 7.1 LED indicators

The PNOZmulti control system is ready for operation when the "POWER" and "RUN" LEDs on the base unit are lit continuously.



### Legend

-  LED on
-  LED flashes
-  LED off



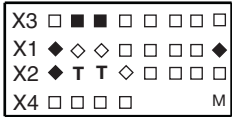
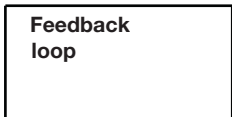
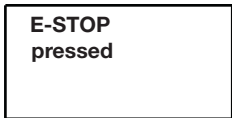
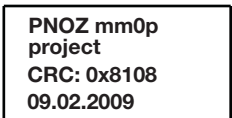

Basis					Error
RUN	DIAG	FAULT	IFAU	OFAU	
●					The existing user program has been deleted.
●					External error on the base unit, leading to a safe condition, e.g. chip card not inserted
●					External error on the base unit outputs, e.g. short across the contacts, leading to a safe condition.
●					Internal error on the base unit
●					Internal error on the base unit (inputs)
●					Internal error on the base unit (outputs)
					Base unit in a STOP condition
					External error on the base unit inputs, which does not lead to a safe condition, e.g. partially operated
					External error on the base unit outputs, which does not lead to a safe condition, e.g. feedback input defective
					The fieldbus module has not been recognised. or The base unit was identified by the PNOZmulti Configurator via the Ethernet interface or An existing fieldbus connection was interrupted.

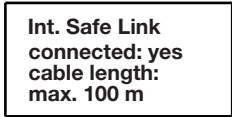
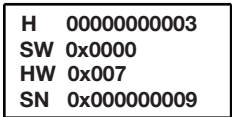
## 7.2 Display indicators

The LC display has four lines. It displays information and navigates the menu:

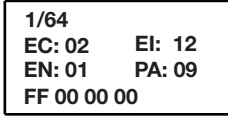
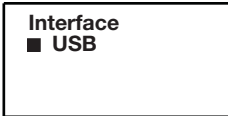
Display	Example	Description
<b>RUN</b> State of inputs/outputs and supply voltage		The lines are assigned terminals X1 ... X4 Status: ■ Input active □ Input inactive ◆ Semiconductor output active ◇ Semiconductor output inactive T Test pulse output Message display (bottom right): M Message present E Error message present
<b>ERROR</b> Status and error messages		Line 1 ... 4: Status and error messages as short text.
<b>DISPLAY MESSAGE</b> Display messages		Line 1 ... 4: Customised messages that are created in the PNOZmulti Configurator.
<b>PROJECT INFO</b> Project information		1st line: Project name 2nd line: Project name 3rd line: Check sum (CRC) 4th line: Creation date
<b>IP ADDRESS</b> IP address of base unit (only appears on base units to which a communication module with Ethernet interface is connected)		2nd line: IP address
<b>INT. SAFE LINK</b> Internal interface for connection of two base units (only appears on devices with an integrated interface for connection of two base units)		1st line: Name of interface 2nd line: Interface connected yes/no 3rd-4th line: Configured cable length (100 m/1000 m)
<b>DEVICE INFO</b> Unit information		1st line: Operating hours since initial commissioning (H) 2nd line: Software version (SW) 3rd line: Hardware version (HW) 4th line: Serial number of PNOZ mm0p (SN)



Display	Example	Description
<b>SHOW ERROR STACK</b> Error stack display		Shows the error stack entries
<b>ERROR STACK</b> Error stack entries		1st line: Consecutive number 2nd line: Error class (EC) and error information (EI) 3rd line: Error number (EN) and error parameter (PA) 4th line: Continuation of error parameter (PA)
<b>INTERFACE</b> Port (only appears on base units to which a communication module is connected)		Show selected interface / on expandable base units: Select interface
<b>STOP Device?</b> Stop Device		Bring device to a STOP condition
<b>RESET PROJECT?</b> Delete project		Delete project from the base unit's memory
<b>EXIT MENU?</b> Exit menu		Exit menu

You can switch between the menu levels by pressing or rotating the knob.

## 7.2.1 Rotary knob

### 7.2.1.1 Function

The menu settings are made on the unit's display via a rotary knob. You have the option to make the settings on the knob by hand or with a screwdriver. If you make the settings with a screwdriver, the knob can remain within the unit.

### 7.2.1.2 Pull out and retract the knob

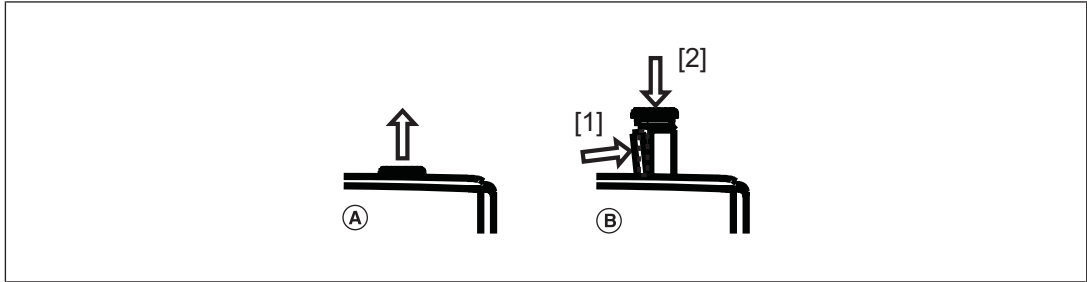

Pull out knob (A):

- ▶ until it locks into position
- ▶ Release knob (B) and push it back into the unit:
  - Press the bar on the side of the knob [1] towards the centre of the knob. This releases the knob.
  - Press the knob downwards [2] while keeping the bar pressed in

### 7.2.1.3 Rotate and press the knob

The settings are made via the rotary knob, as follows:

Press the knob

- ▶ Confirm selection/setting
- ▶ Switch to menu

Rotate knob

- ▶ Select menu level



### 7.2.2 Switch between menu levels

Schematic representation of the menu functions

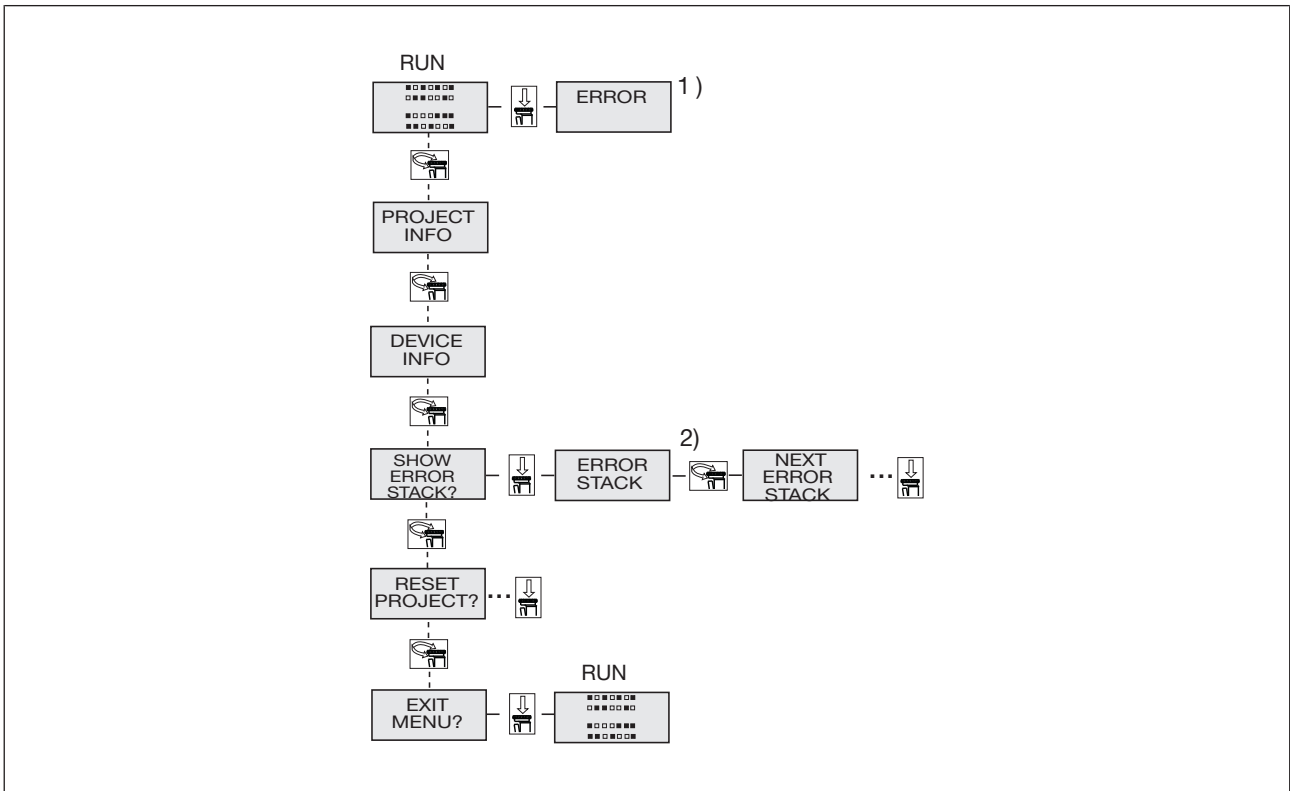

1) Further information on error messages can be found under "Unit diagnostics on the LC display"

2) Further information on the error stack can be found under "Error stack on the LC display"

### 7.2.3 Unit diagnostics on the LC display

Procedure for showing error messages on the LC display, when the errors do not lead to a safe condition:

- ▶ Use the rotary knob to display stored errors:

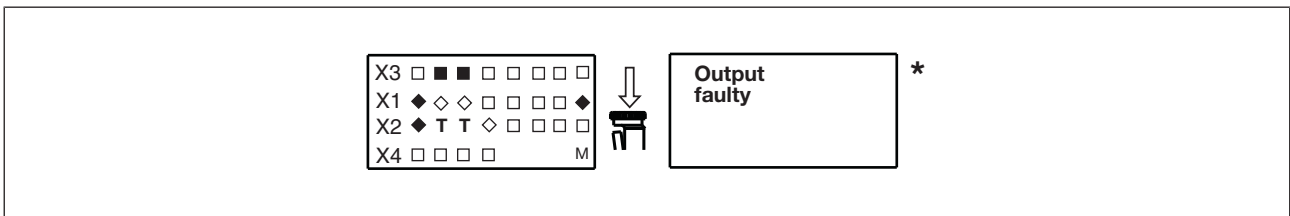

\* If an error leads to a safe condition, the error message appears on the display immediately. Once the cause has been rectified, you will need to reset the unit

Procedure for resetting the unit:

- ▶ Press the rotary knob for between 3 and 8 seconds to reset the unit.

Error messages	Errors
FAULTY PROJECT	Chip card contains a project which is faulty or incompatible.
CHIP CARD ?	Chip card is not inserted, blank or unreadable
FAULTY TEST PULSE	Error caused by test pulse
PARTIALLY OPERATED	Function element was or is partially operated
FEED BACK LOOP	External error at the feedback loop inputs
OPERATING MODE SWITCH SELECTOR	Error on the operating mode selector switch function element
FAULTY OUTPUT	External error on the output
OUTPUT WITH ADVANCED FAULT DETECTION	External error on the output with advanced fault detection
LOAD SUPPLY	Error in the supply voltage for the semiconductor outputs
FAULTY DEVICE	Internal error on the base unit.
SUPPLY LOW	Supply voltage is below the tolerance level
SUPPLY HIGH	Supply voltage exceeds the tolerance level
RELAY DEVICE?	Error on the expansion module with relay outputs
RELAY DEVICE OR TERMINATION PLUG?	Error on the expansion module with relay outputs or on the connector

### 7.2.4 Error stack on the LC display

The error stack can be read from the PNOZmulti Configurator or shown on the LC display. The error stack helps Pilz technical support with fault diagnostics. The error stack can store up to 64 status and error messages.

The following information is shown on the LC display:

- ▶ Sequential number of an error stack entry. A new error stack entry is stored in first place.
- ▶ Error class (EC) and error information (EI)
- ▶ Error number (EN) and five error parameters (PA)

Procedure for displaying the error stack on the LC display:

- ▶ Use the rotary knob to display the error stack.

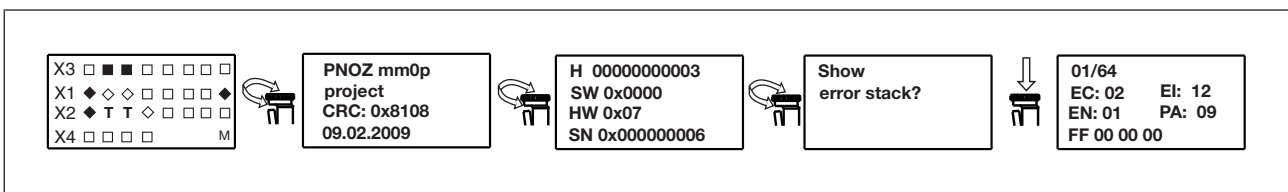

**INFORMATION**

Use the rotary knob to exit the error stack.

Procedure for reading the error stack with the PNOZmulti Configurator:

- ▶ See online help for the PNOZmulti Configurator

## 8 Technical details

<b>General</b>	
Approvals	BG, CCC, CE, EAC (Eurasian), KCC, TÜV, cULus Listed
<b>Electrical data</b>	
Supply voltage	
for	<b>Supply to the system</b>
Voltage	<b>24,0 V</b>
Kind	<b>DC</b>
Voltage tolerance	<b>-15 %/+20 %</b>
Output of external power supply (DC)	<b>35,0 W</b>
Output of external power supply (DC) at no load	<b>8,0 W</b>
Residual ripple DC	<b>5 %</b>
Supply voltage	
for	<b>Supply to the SC outputs</b>
Voltage	<b>24 V</b>
Kind	<b>DC</b>
Voltage tolerance	<b>-15 %/+20 %</b>
Output of external power supply (DC)	<b>192,0 W</b>
Status indicator	<b>Display, LED</b>
<b>Configurable inputs/outputs (inputs or auxiliary outputs)</b>	
Number	<b>8</b>
Galvanic isolation	<b>No</b>
Configurable inputs	
Input voltage in accordance with EN 61131-2 Type 1	<b>24,0 V</b>
Input current at rated voltage	<b>5 mA</b>
Min. pulse duration	<b>16 ms</b>
Pulse suppression	<b>0,6 ms</b>
Signal level at "1"	<b>15 ... 30 V DC</b>
Signal level at "0"	<b>-3 ... +5 V DC</b>
Maximum input delay	<b>4,0 ms</b>
Configurable auxiliary outputs	
Voltage	<b>24,0 V</b>
Output current	<b>75 mA</b>
Power	<b>1,8 W</b>
Short circuit-proof	<b>yes</b>
Residual current at "0"	<b>0,5 mA</b>
Voltage at "1"	<b>UB - 2 V at 0.1 A</b>
<b>Inputs</b>	
Number	<b>12</b>
Signal level at "0"	<b>-3 - +5 V DC</b>
Signal level at "1"	<b>15 - 30 V DC</b>

<b>Inputs</b>	
Input voltage in accordance with EN 61131-2 Type 1	<b>24 V DC</b>
Input current at rated voltage	<b>5 mA</b>
Min. pulse duration	<b>16 ms</b>
Pulse suppression	<b>0,6 ms</b>
Maximum input delay	<b>4 ms</b>
Potential isolation	<b>No</b>
<b>Semiconductor outputs</b>	
Number	<b>4</b>
Switching capability	
Voltage	<b>24 V</b>
Current	<b>2,0 A</b>
Power	<b>48 W</b>
Signal level at "1"	<b>UB - 0.5 VDC at 2 A</b>
Residual current at "0"	<b>0,5 mA</b>
Max. capacitive load	<b>1 µF</b>
Max. duration of off time during self test	<b>330 µs</b>
Switch-off delay	<b>30 ms</b>
Potential isolation	<b>yes</b>
Short circuit-proof	<b>yes</b>
<b>Test pulse outputs</b>	
Number of test pulse outputs	<b>4</b>
Voltage	<b>24 V</b>
Current	<b>0,1 A</b>
Max. duration of off time during self test	<b>5 ms</b>
Short circuit-proof	<b>yes</b>
Potential isolation	<b>No</b>
<b>Times</b>	
Switch-on delay	<b>5,00 s</b>
Supply interruption before de-energisation	<b>20 ms</b>
Simultaneity, channel 1 and 2 max.	<b>3 s</b>
Simultaneity in the two-hand circuit	<b>0,5 s</b>
<b>Environmental data</b>	
Ambient temperature	
In accordance with the standard	<b>EN 60068-2-14</b>
Temperature range	<b>0 - 60 °C</b>
Forced convection in control cabinet off	<b>55 °C</b>
Storage temperature	
In accordance with the standard	<b>EN 60068-2-1/-2</b>
Temperature range	<b>-25 - 70 °C</b>
Climatic suitability	
In accordance with the standard	<b>EN 60068-2-30, EN 60068-2-78</b>
Humidity	<b>93 % r. h. at 40 °C</b>
Condensation during operation	<b>Not permitted</b>
EMC	<b>EN 61131-2</b>

<b>Environmental data</b>	
Vibration	
In accordance with the standard	<b>EN 60068-2-6</b>
Frequency	<b>10,0 - 150,0 Hz</b>
Acceleration	<b>1g</b>
Shock stress	
In accordance with the standard	<b>EN 60068-2-27</b>
Acceleration	<b>15g</b>
Duration	<b>11 ms</b>
Max. operating height above sea level	<b>2000 m</b>
Airgap creepage	
In accordance with the standard	<b>EN 61131-2</b>
Overvoltage category	<b>II</b>
Pollution degree	<b>2</b>
Rated insulation voltage	<b>30 V</b>
Rated impulse withstand voltage	<b>2,50 kV</b>
Protection type	
In accordance with the standard	<b>EN 60529</b>
Mounting area (e.g. control cabinet)	<b>IP54</b>
Housing	<b>IP20</b>
Terminals	<b>IP20</b>
<b>Potential isolation</b>	
Potential isolation between	<b>SC output and system voltage</b>
Type of potential isolation	<b>Basic insulation</b>
Rated surge voltage	<b>2500 V</b>
<b>Mechanical data</b>	
Mounting position	<b>Horizontal on top hat rail</b>
DIN rail	
Top hat rail	<b>35 x 7,5 EN 50022</b>
Recess width	<b>27 mm</b>
Max. cable length	
Max. cable length per input	<b>1,0 km</b>
Sum of individual cable lengths at the test pulse output	<b>2 km</b>
Material	
Bottom	<b>PC</b>
Front	<b>PC</b>
Top	<b>PC</b>
Connection type	<b>Spring-loaded terminal, screw terminal</b>
Conductor cross section with screw terminals	
1 core flexible	<b>0,25 - 2,50 mm<sup>2</sup>, 24 - 12 AWG</b>
2 core with the same cross section, flexible without crimp connectors or with TWIN crimp connectors	<b>0,20 - 1,50 mm<sup>2</sup>, 24 - 16 AWG</b>
Torque setting with screw terminals	<b>0,50 Nm</b>
Conductor cross section with spring-loaded terminals:	
Flexible with/without crimp connector	<b>0,20 - 2,50 mm<sup>2</sup>, 24 - 12 AWG</b>



Mechanical data	
Spring-loaded terminals: Terminal points per connection	2
Stripping length with spring-loaded terminals	9 mm
Dimensions	
Height	100,0 mm
Width	45,0 mm
Depth	120,0 mm
Weight	231 g

Where standards are undated, the 2010-08 latest editions shall apply.

## 8.1 Safety characteristic data



### NOTICE

You must comply with the safety-related characteristic data in order to achieve the required safety level for your plant/machine.

Unit	Operating mode	EN ISO 13849-1: 2015 PL	EN ISO 13849-1: 2015 Category	EN 62061 SIL CL	EN 62061 PFH <sub>D</sub> [1/h]	EN ISO 13849-1: 2015 T <sub>M</sub> [year]
<b>Logic</b>						
CPU	2-channel	PL e	Cat. 4	SIL CL 3	1,54E-09	20
Expansion right	–	PL e	Cat. 4	SIL CL 3	2,13E-10	20
Expansion left	–	PL e	Cat. 4	SIL CL 3	2,38E-10	20
<b>Input</b>						
SC inputs	1-channel	PL d	Cat. 2	SIL CL 2	3,95E-09	20
SC inputs	2-channel	PL e	Cat. 4	SIL CL 3	4,61E-10	20
SC inputs	Short circuit-forming safety mats	PL d	Cat. 3	SIL CL 2	1,86E-09	20
SC inputs	1-ch., pulsed light barrier	PL e	Cat. 4	SIL CL 3	3,95E-10	20
<b>Output</b>						
SC outputs	1-channel with advanced fault detection	PL e	Cat. 4	SIL CL 3	7,65E-10	20
SC outputs	1-channel	PL d	Cat. 2	SIL CL 2	8,90E-10	20
SC outputs	2-channel	PL e	Cat. 4	SIL CL 3	7,86E-10	20

All the units used within a safety function must be considered when calculating the safety characteristic data.

**INFORMATION**

A safety function's SIL/PL values are **not** identical to the SIL/PL values of the units that are used and may be different. We recommend that you use the PAScal software tool to calculate the safety function's SIL/PL values.

## 9 Supplementary data

### 9.1 Maximum capacitive load $C$ ( $\mu\text{F}$ ) with load current $I$ (A) at the semiconductor outputs

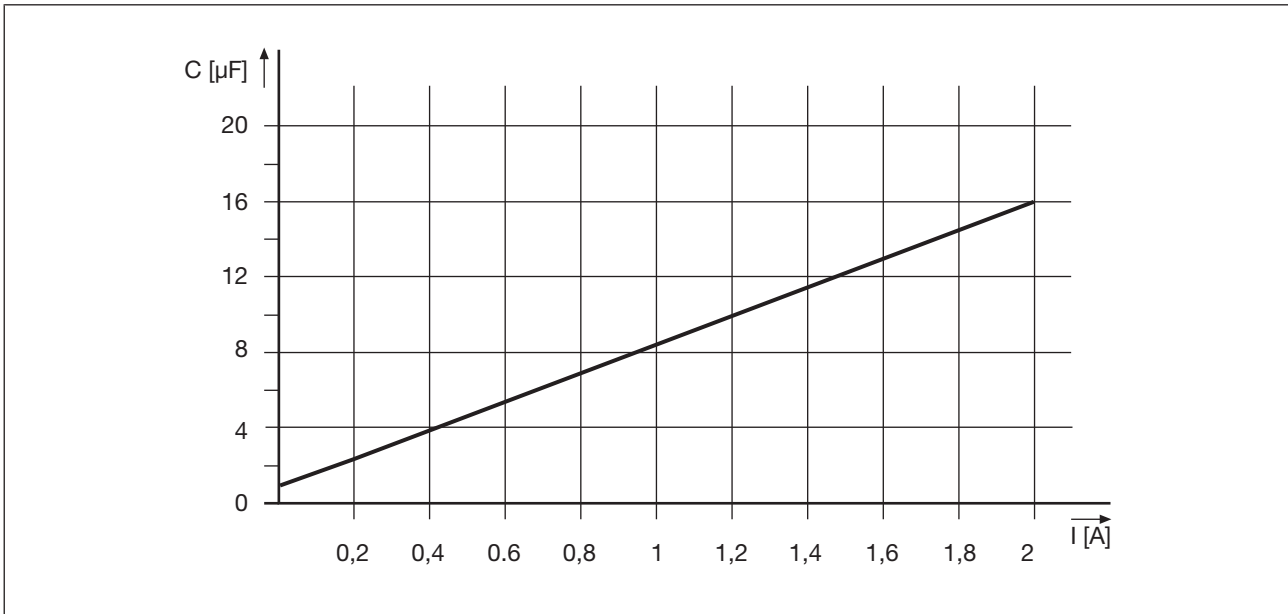

### 9.2 Maximum permitted total current of the semiconductor outputs

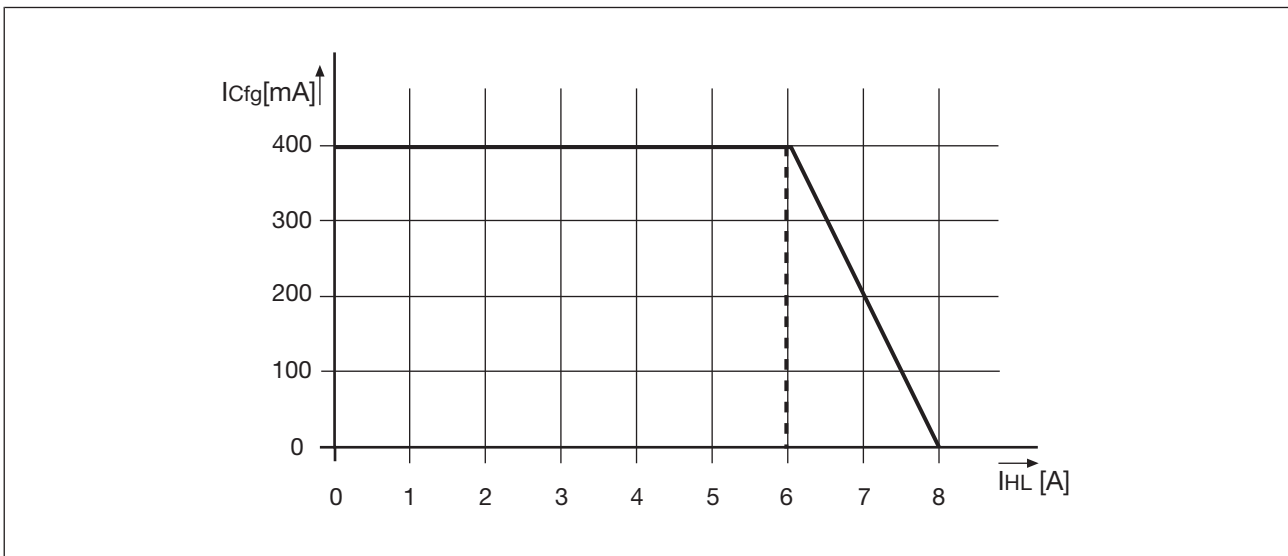

$I_{Cfg}$ : Total current of the configurable semiconductor outputs (auxiliary outputs)

$I_{HL}$ : Total current: Semiconductor outputs (safety outputs)

## 10 Order reference

### 10.1 Product

Product type	Features	Order No.
PNOZ mm0.1p	Base unit	772 001

### 10.2 Accessories

#### Terminator

Product type	Features	Order No.
PNOZ s terminator plug	Right terminator, yellow, x10	750 010
PNOZ mm0.xp terminator left	Left terminator, black/yellow, x1	779 261

#### Cable

Product type	Features	Order no.
PSSu A USB-CAB03	Mini USB cable, 3 m	312 992
PSSu A USB-CAB05	Mini USB cable, 5 m	312 993

#### Terminals

Product type	Features	Order no.
PNOZ s Set1 spring loaded terminals	1 set of spring-loaded terminals	751 008
PNOZ s Set1 screw terminals	1 set of screw terminals	750 008

# ► Support

Technical support is available from Pilz round the clock.

## Americas

**Brazil**  
+55 11 97569-2804

**Canada**  
+1 888-315-PILZ (315-7459)

**Mexico**  
+52 55 5572 1300

**USA (toll-free)**  
+1 877-PILZUSA (745-9872)

## Asia

**China**  
+86 21 60880878-216

**Japan**  
+81 45 471-2281

**South Korea**  
+82 31 450 0680

## Australia

+61 3 95446300

## Europe

**Austria**  
+43 1 7986263-0

**Belgium, Luxembourg**  
+32 9 3217575

**France**  
+33 3 88104000

**Germany**  
+49 711 3409-444

**Ireland**  
+353 21 4804983

**Italy**  
+39 0362 1826711

## Scandinavia

+45 74436332

## Spain

+34 938497433

## Switzerland

+41 62 88979-30

## The Netherlands

+31 347 320477

## Turkey

+90 216 5775552

## United Kingdom

+44 1536 462203

## You can reach our international hotline on:

+49 711 3409-444  
support@pilz.com

Pilz develops environmentally-friendly products using ecological materials and energy-saving technologies. Offices and production facilities are ecologically designed, environmentally-aware and energy-saving. So Pilz offers sustainability, plus the security of using energy-efficient products and environmentally-friendly solutions.



Pilz GmbH & Co. KG  
Felix-Wankel-Straße 2  
73760 Ostfildern, Germany  
Tel.: +49 711 3409-0  
Fax: +49 711 3409-133  
info@pilz.com  
www.pilz.com

